

Owner's Manual

Ceiling Fan Installation Instructions

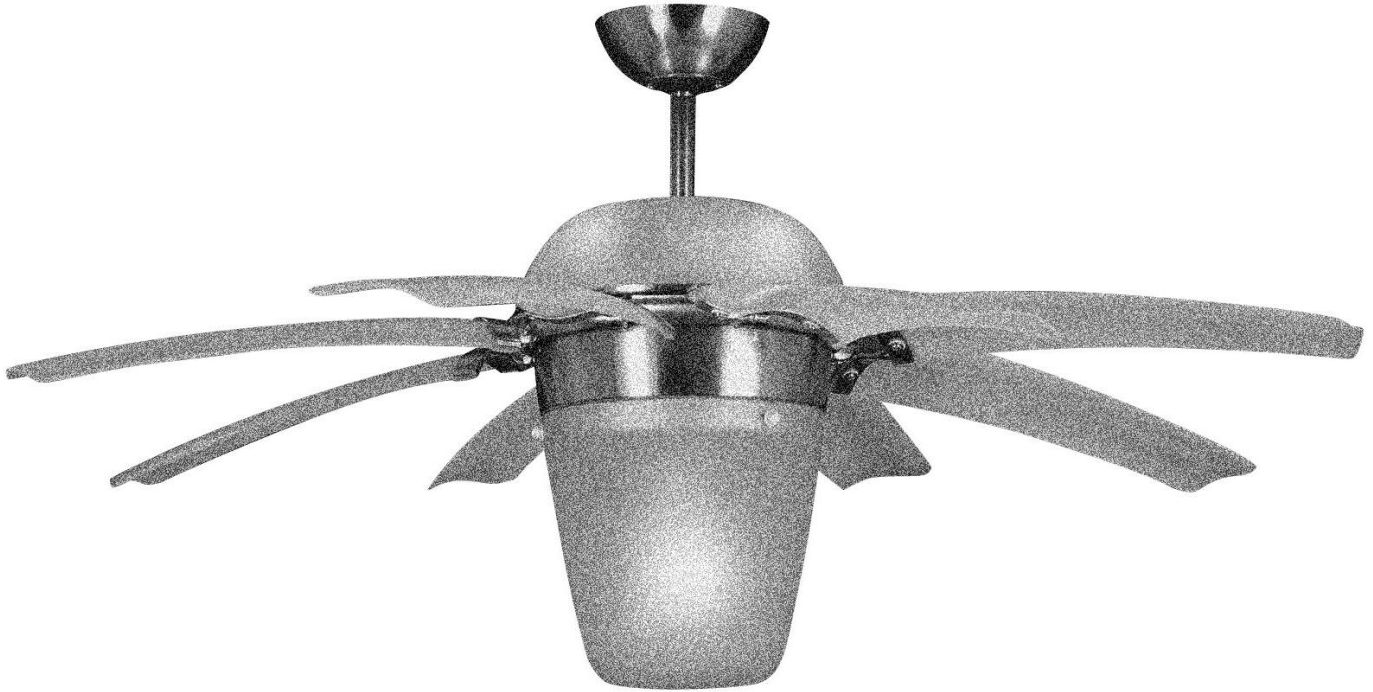

Total fan weight
with light

For 8ATR44 Series Fans

READ AND SAVE THESE INSTRUCTIONS

MONTE CARLO
Quality Ceiling fans



Installation

SAFETY TIPS

WARNING: TO REDUCE THE RISK OF FIRE, ELECTRIC SHOCK, OR INJURY TO PERSONS, OBSERVE THE FOLLOWING: READ AND SAVE THESE INSTRUCTIONS

1. Installation work and electrical wiring must be done by qualified person(s) in accordance with applicable codes and standards (ANSI/NFPA 70-1999), including fire-rated construction.
2. Use this unit only in the manner intended by the manufacturer. If you have any questions contact the manufacturer.
3. After making the wire connections, the wires should be spread apart with the grounded conductor and the equipment-grounding conductor on one side of the outlet box and ungrounded conductor on the other side of the outlet box.
4. Before you begin installing the fan, Switch power off at Service panel and lock service disconnecting means to prevent power from being switched on accidentally. When the service disconnecting means cannot be locked, securely fasten a prominent warning device, such as a tag, to the service panel.
5. Be cautious! read all instructions and safety information before installing your new fan. Review the accompanying assembly diagrams.
6. When cutting or drilling into wall or ceiling, do not damage electrical wiring and other hidden utilities.
7. Make sure the installation site you choose allows the fan blades to rotate without any obstructions. Allow a minimum clearance of 7 feet from the floor to the trailing edge of the blade.
8. To reduce the risk of fire, electric shock, or personal injury, mount to outlet box or supporting system acceptable for fan support. (Mounting must support at least 35 lbs.)
9. Do not bend blade holders during installation to motor, balancing or during cleaning. Do not insert foreign object between rotating blades.
10. Attach the mounting bracket using only the hardware supplied with the outlet box.
11. To reduce the risk of fire or electric shock, do not use this fan with any solid state fan speed control device, or variable speed control.
12. If this unit is to be installed over a tub or shower, it must be marked as appropriate for the application.
13. NEVER place a switch where it can be reached from a tub or shower.
14. The combustion airflow needed for safe operation of fuel-burning equipment may be affected by this unit's operation. Follow the heating equipment manufacturer's guideline safety standards such as those published by the National Fire Protection Association (NFPA), and the American Society for Heating, Refrigeration and Air Conditioning Engineers (ASHRAE) and the local code authorities.
15. Before servicing or cleaning unit, Switch power off at Service panel and lock service disconnecting means to prevent power from being switched on accidentally. When the service disconnecting means cannot be locked, securely fasten a prominent warning device, such as a tag, to the service panel.

TOOLS REQUIRED

Phillips Screwdriver

Wire Cutters

Pliers

Step Ladder



1
Before you begin installing the fan, Switch power off at Service panel and lock service disconnecting means to prevent power from being switched on accidentally. When the service disconnecting means cannot be locked, securely fasten a prominent warning device, such as a tag, to the service panel.

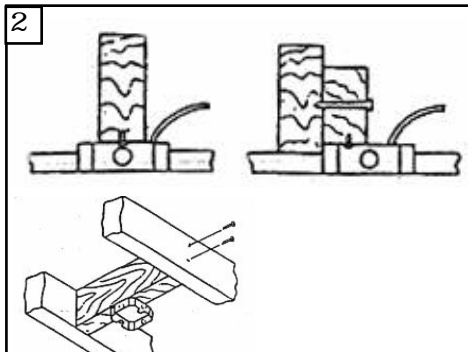

2
Before installing this fan make sure the outlet box is properly installed to the house structure. To reduce the risk of fire, electric shock, or personal injury, mount to outlet box or supporting system acceptable for fan support. (Mounting must support at least 35 lbs.)

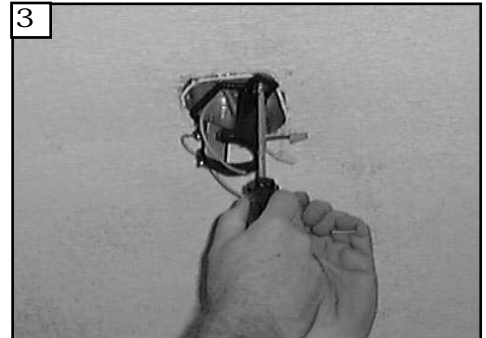

3
Install the Mounting Bracket to the Outlet box. Use only the screws provided with the outlet box.



4
Install 4 x 15 watt candelabra torpedo shape bulbs.

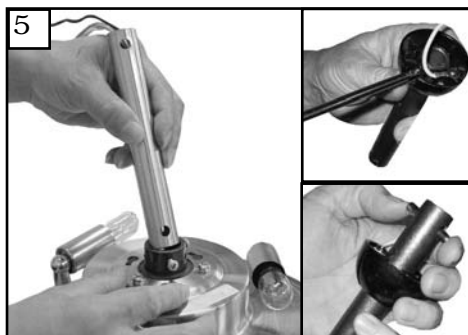

5
Loosen screw holding half ball and remove pin from downrod. Thread wires and safety cable through downrod and insert downrod into motor yoke.



6
Insert clevis pin through yoke and downrod and secure with keeper pin. (see inset)

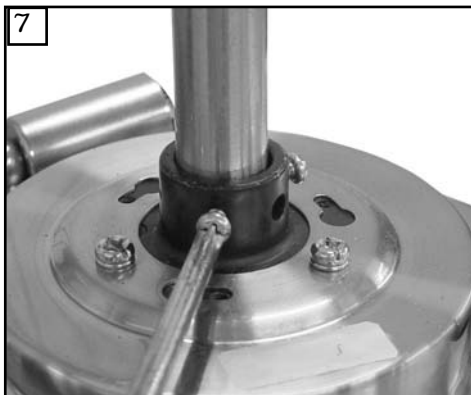

7
Tighten both yoke set screws and lock nuts to further secure downrod.

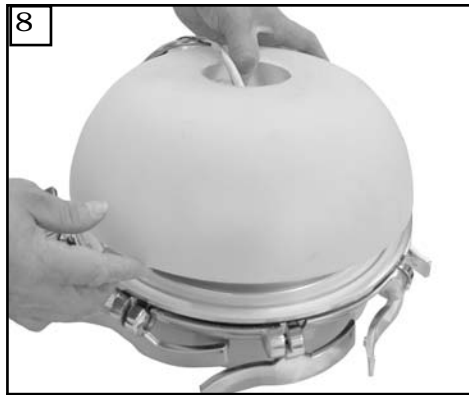

8
Install upper glass over downrod onto fan body.

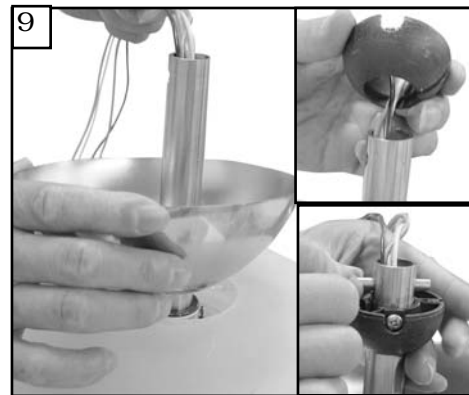

9
Install canopy over downrod. Caution: Replace pin and ball onto downrod.

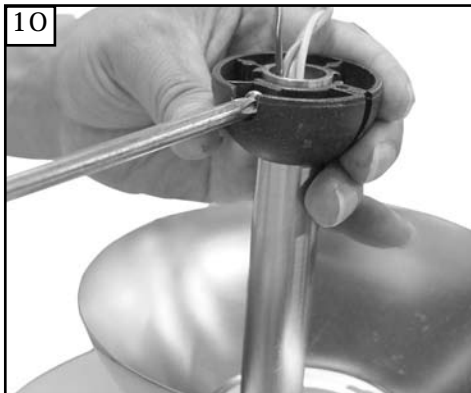

10
Tighen set screw loosened in step 5.

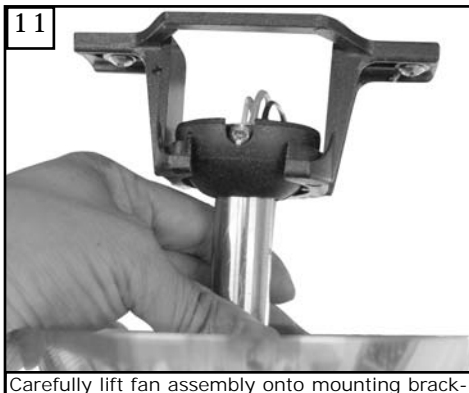

11
Carefully lift fan assembly onto mounting bracket. Rotate fan so that the notch on the ball engages the ridge in the mounting bracket. This will allow hands-free wiring.

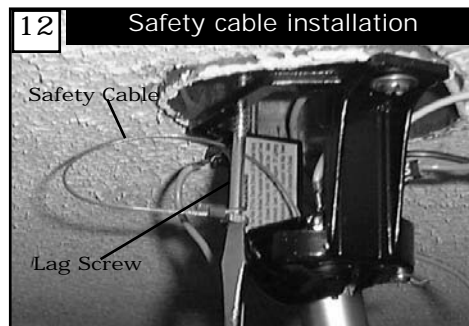

12 **Safety cable installation**
For Canadian installation and for USA fan and light kit combinations over 35 lbs, in both flush and downrod mode the safety cable must be installed into the house structure beams using the 3" lag screws provided. Make sure that when the safety cable is fully extended the leadwires are longer than the cable and no stress is placed on the leadwires.

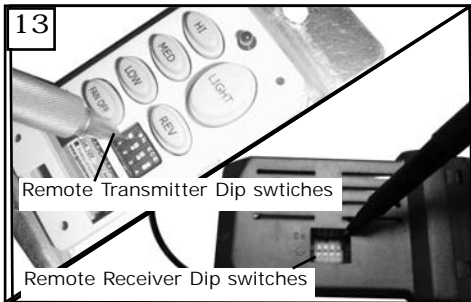

13
Set dip switches on the Remote Transmitter and Remote Receiver to the same settings. This must be done so the units will communicate properly. If you have other fans you can set to control from one transmitter by setting both receivers the same as the transmitter. If you have more than one fan with remote. You can set the dip switches to different positons to have seperate control.

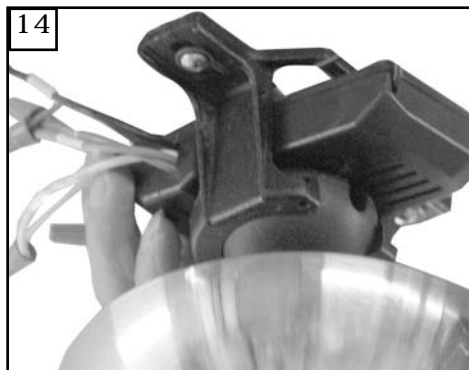

14
Install remote receiver by sliding into opening in the mounting bracket. Make sure that the dip switches on the transmitter and the receiver are set to the same positions.

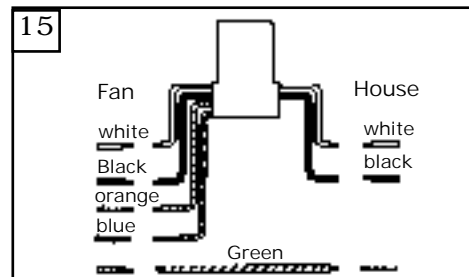

15
Make wiring connections as indicated above. White from fan to white from remote marked N. Orange from fan to Orange from remote marked Light/up. Blue from fan to blue from remote marked down light. Black from fan to Black from remote marked L. White from house to white from remote marked AC N. Black from house to Black from remote marked AC L. Connect all green ground wires to Ground wire from House.



16
Make wire connections to power source using wire nuts provided. Make sure that no filiments are outside of the wirenut. After making the wire connections, the wires should be spread apart with the grounded conductor and the equipment-grounding conductor on one side of the outlet box and ungrounded conductor on the other side of the outlet box.

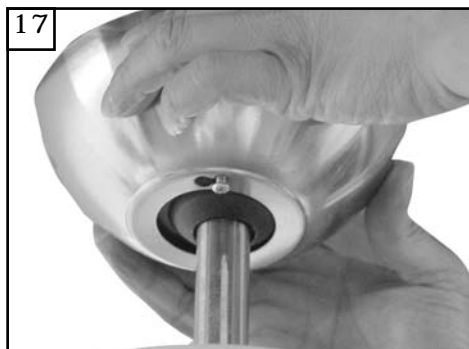

17
Raise the canopy up and align the two holes in the canopy with the two holes in the hanger bracket. Secure with two screws provided.



18
Install 1 x 100 watt Edison base bulb.



19 Install glass to fan.



20 Install glass to fan using the 3 ball screws provided.



21 Attach blade assembly to arms from motor housing using screws and washers provided. Tighten screws securely.



22 Remove cover by snapping off from top or bottom. Install 12V battery into wall remote. Duracell MN21 / Eveready A23 / GP 23A all 12V.

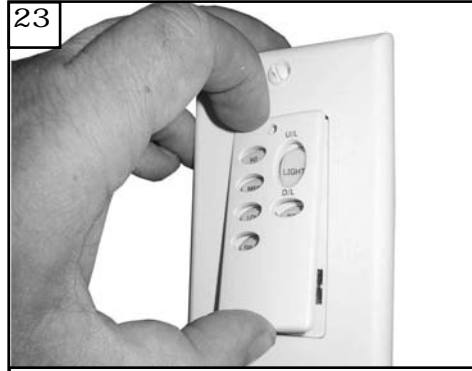

23 Attach cover of remote by placing over buttons and snapping into place.

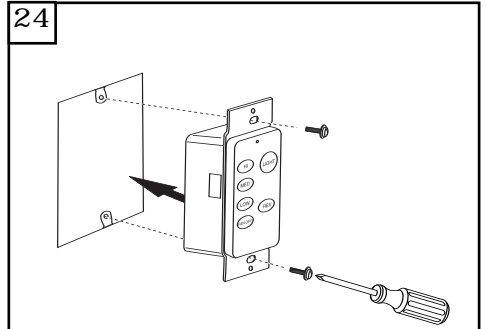

24 Install wall control unit to outlet box using machine screws provided.

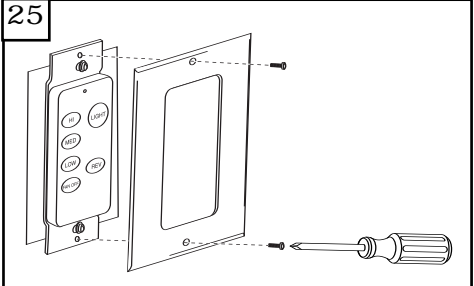

25 Attach front cover to wall control with screws provided.

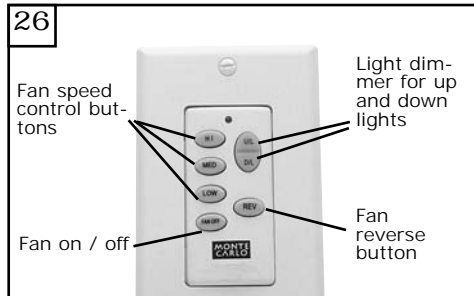

26 To control fan speed select from High, Medium or low speed buttons. To turn the fan off press the Fan on / off button. To dim upper lights press and hold U/L button. To dim Lower lights press and hold D/L button. To turn off either up or down light press and quickly release either U/L or D/L button. Press button marked REV to reverse the rotation direction of the fan blades

Trouble Shooting

If you have difficulty operating your new ceiling fan, it may be the result of incorrect assembly, installation, or wiring. In some cases, these installation errors may be mistaken for defects. If you experience any faults, please check this Trouble Shooting Chart. If a problem cannot be remedied, or you are experiencing difficulty in installation, please call our Customer Service Center at the number printed on your parts list insert sheet.

Warning: Before servicing or cleaning unit, Switch power off at Service panel and lock service disconnecting means to prevent power from being switched on accidentally. When the service disconnecting means cannot be locked, securely fasten a prominent warning device, such as a tag, to the service panel.

1. If fan does not start:
1. Check main and branch circuit fuses or circuit breakers.
 2. Check line wire connections to fan and switch wire connections in switch housing.
 3. Check to make sure the dip switches from the transmitter and receiver are set on the same frequency.

CAUTION: Make sure main power is turned off

2. If fan sounds noisy:
1. Check to make sure all screws in motor housing are snug (not over tightened).
 2. Check to make sure the screws which attach the fan blade holder to the motor are tight.
 3. Check to make sure wire nut connectors in switch housing are not rattling against each other or against the interior wall of the switch housing.

CAUTION: Make sure main power is turned off before entering switch housing.

4. Some fan motors are sensitive to signals from Solid State variable speed controls. **DO NOT USE a Solid State variable speed control.**
5. Allow "break-in" period of 24 hours. Most noises associated with a new fan will disappear after this period.

3. If fan wobbles:
1. Make sure that the ridge of the canopy engages the notch in the downrod ball.
 2. Check that all blades are screwed firmly into blade holders.
 3. Check that all blade holders are tightened securely to motor.
 4. Make sure that canopy and mounting bracket are tightened securely to ceiling junction box and junction box is mounted firmly to ceiling joist.
 5. Dynamic balancing involves 'counter-weighting'. By using a small weight opposite to the point of wobble, you can in almost all cases eliminate the wobble. The procedure requires much trial and error, and a certain amount of patience to achieve the correct position of the counterweight.
A) Determine which fan speed causes the most wobble. This will almost always be the highest speed. B) Turn the fan off. Select any one blade and place the balance clip half way between the blade tip and blade holder, on the rear edge of the blade. **Caution: Be careful to stay clear of the blades when running. If the clip is not secure, injury may result from the clip flying off.** C) Turn the fan on. Observe if the wobble is better or worse. Turn the fan off and move the clip to the next blade. Do the same for all blades and note on which blade the clip improves the wobble the most. D) Place the clip on the blade which showed the most improvement and by trial and error move the clip in and out along the blade to find the position which most improves the wobble. E) Remove the clip and discard. Once the exact position is determined, place a weight on bottom of the metal blade holder on its centerline. Press the weight firmly to ensure it is firmly attached to the blade holder. Add more weight as needed to balance.



4. If light does not work:
1. Check wire from fan to make sure it is connected to hot wire from house.
 2. Check for loose or disconnected wires in fan switch housing.
 3. Check for loose or disconnected wires in light kit.
 4. Check for faulty light bulbs.

CAUTION: Make sure main power is turned off before entering switch housing.

WARNING: Before attempting to replace the fuse make sure the main power is turned off to the fan. Replace only with 3 amp fuse.

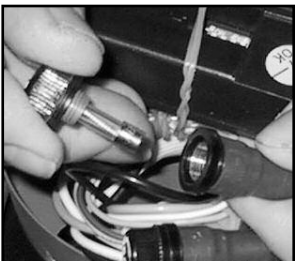

MONTE CARLO

Customer Service Center:
740 S.W. Loop 820, Suite 110
Fort Worth, Texas 76115
1-800-519-4092